



Florida Building Code - Energy Conservation - 2017 - 6th Edition

nLight® Applications Guide





/ nLight Lighting Controls Platform

It's not just smarter. It's easier.

nLight is a sensor-based digital lighting controls solution that offers wired and wireless lighting controls that easily connect luminaires, sensors, and other control devices to create a digital network. The nLight platform of products enables ease in specification, installation, and ownership, making it the go-to digital lighting controls platform for specifiers, contractors, and building owners.



/ TABLE OF CONTENTS

- 04 Code Requirements for Common Building Spaces
- 05 How to Use This Guide
- 06 Enclosed Office Solutions
- 08 Open Plan Office Solutions
- 10 Conference Room Solutions
- 12 Classroom Solutions
- 14 Lobby Solutions
- 16 Corridor Solutions
- 18 Restroom Solutions
- 20 Stairwell Solutions
- 21 Gymnasium Solutions
- 22 Warehouse/Storage Solutions
- 23 Parking Area (Garage), Interior
- 24 Exterior Lighting
- 25 nLight® Hybrid Networked Lighting Control
- 26 Requirements Overview
- 28 Luminaires with Networked Embedded Controls from nLight & Mobile Apps
- 29 Specification Tools



/ ABOUT

About Florida Building Code 2017

Florida Building Code's Energy Conservation section is an energy code designed to reduce energy consumption. The 2017 version has specific requirements for lighting controls. The use of advanced lighting controls to synchronize light levels with daylight, occupancy, and multi-level control capability are required in order to be compliant.

About this Guide

Acuity Brands® offers the nLight® Florida Building Code Applications Guide as a reference of typical nLight layouts that help make code compliance quicker and easier. The Acuity Brands Design Services Team is also available to support engineers and contractors with detailed design, submittal, and installation. For additional information, please contact your Acuity Brands Sales Representative.

About nLight

nLight® is a sensor-based digital lighting controls solution that offers wired and wireless lighting controls that easily connect luminaires, sensors, and other control devices to create one digital lighting controls platform to aid in code compliance, reduce energy, and enable advanced networked capabilities. Ideal for practically any application, small to large, indoor to outdoor, nLight offers lighting controls that scale from one room to an entire floor, from one floor to an entire building, from one building to an entire campus.

The chart below is an overview of the Code Requirements for Common Building Spaces. Please use this information as a guide. For specific code requirements please refer to the Florida Building Code - Energy Conservation - 2017 - 6th Edition.

	Control Requirement*	Code Provision	Code Summary*	Space Type									
				Private Office	Open Office	Conference, Meeting, Multipurpose Room	Classroom, Lecture Hall, Training Room	Lobby	Corridor	Public Restroom	Private Restroom	Non-Exit Stairwell	Gymnasium
On-Off Control	Manual-On or AutoOn ≤ 50%	C405.2.1.1.2	Automatically controlled spaces must be controlled to automatically turn the lighting on to not more than 50% power.	✓	✓	✓	✓						
	Full Automatic-On	C405.2.1.1.2	Automatically controlled spaces are allowed to turn on to full.					✓	✓	✓	✓	✓	
	Auto-Off ≤ 50%	C405.2.1.2	Occupancy sensors shall automatically reduce lighting in warehouse aisle-ways and open areas by ≤ 50%										
	Full Auto-Off via Occupancy Sensor	C405.2.1.1.1	Fixtures must automatically turn off within 30 minutes of all occupants leaving the space.	✓	✓	✓	✓	✓	✓	✓	✓	✓	✓
	Time-Switch Controls (via System Controller)	C405.2.2.1	Each area of the building not provided with occupant sensor controls shall be provided with time switch controls. These areas must also be provided with a manual override switch.		(or)			(or)	(or)			(or)	(or)
	Light Reduction Controls	C405.2.2.2	Spaces shall have a manual control that allows the occupant to reduce the connected lighting load uniformly by at least 50%.		+							+	+
	Manual Control (Local Switch)	C405.2.2.3	Areas shall incorporate a manual control to allow occupants to turn fixtures off.	✓	✓	✓	✓	✓	✓	✓	✓	✓	✓
Additional Controls	Automatic Receptacle (i.e. Plug Load Control)	C405.6.1	50% of receptacles and 25% of branch circuit feeders installed for modular furniture shall be automatically turned off by occupancy sensor within 20 minutes of all occupant leaving the space, or by time schedule.	✓	✓	✓	✓						
Daylight Control	Daylight-Responsive Controls	C405.2.3.1/2	Daylight-responsive controls shall be provided within each space with sidelight and toplight daylight zones totaling > 150W. Lighting in offices, classrooms, labs, and library reading rooms shall dim continuously down to 15%.	✓	✓	✓	✓	✓	✓	✓	✓	✓	✓
Exterior Control	Exterior Lighting Controls	C405.2.5	C405.2.5.1 Daylight shutoff C405.2.5.2 Facade and Landscape Lighting Shutoff C405.2.5.3 Light Reduction by Schedule or Occupancy Sensing										

* Note: This summary is for general information purposes only and is provided without any warranty as to accuracy, completeness, or otherwise. The user should read the applicable code sections for more complete and detailed descriptions of code requirements and exceptions and should consult with a professional engineering or other competent advisor before making any decision or taking any action based on this summary.

Warehouse	Parking Garage	Site Lighting
✓		
✓		
(or)		
✓		
✓		
	✓	✓

For each space type there will be a wired solution on the left and wireless solution on the right.

Room description

Room layout diagram with controls, fixtures, and wiring

6 ENCLOSED OFFICE: < 250 sq. ft., Windows, Luminaire with Networked Embedded Controls from nLight

Wired

Wireless

Symbol	Qty	Product #	Description
[Troffer]	2	See Note	Troffer with Wired Networked Embedded Controls from nLight
[Wall Pod]	1	nWSXA PDT LV DX	Wall Switch Occupancy Sensor with On/Off, Raise/Lower
[Relay Pack]	1	nPP20 PL	Plug Load Relay Pack

Symbol	Qty	Product #	Description
[Troffer]	2	See Note	Troffer with Wireless Networked Embedded Controls from nLight with Sensor Option
[Wall Pod]	1	rPODBA DX G2	Battery Powered, On/Off, Raise/Lower WallPod
[Relay Pack]	1	rPP20 24V EFP G2	Plug Load Relay Pack

OPERATIONAL DETAILS:

Light Fixtures:

- All fixtures are dimmable
- All fixtures can be controlled together or independently
- Maximum level can be task tuned to any percentage via programming

Occupancy Control:

- Fixtures must be turned on manually (or optionally can be configured to come on automatically to 50%)
- Plug-load turns on automatically
- Fixtures and plug-load turn off automatically when room becomes vacant

Daylight Control:

- Not required for offices without windows or that have loads < 150W in sidelit zones

Manual Control:

- On/off & raise/lower control of fixtures

ADDITIONAL OPTIONS:

- Room can be connected to nLight backbone to enable network control or time schedules
- HVAC control available through system-wide BACnet® interface option on the ECLYPSE® controller
- Luminaires with wireless networked embedded controls from nLight and occupancy/daylighting sensor options available, please see the fixture specification sheet
- For emergency lighting control use a power pack with ER/EM option or luminaire with networked embedded controls from nLight with emergency option

Note: Contact your local lighting agent for more information on luminaires with networked embedded controls from nLight.

www.nlightcontrols.com • 800-535-2465

Wire type legend

Required list of devices in order to implement room layout design above

Operational details describe the functionality provided by the equipment specified in the solution

Additional options that add control capacity beyond code requirements

Wired

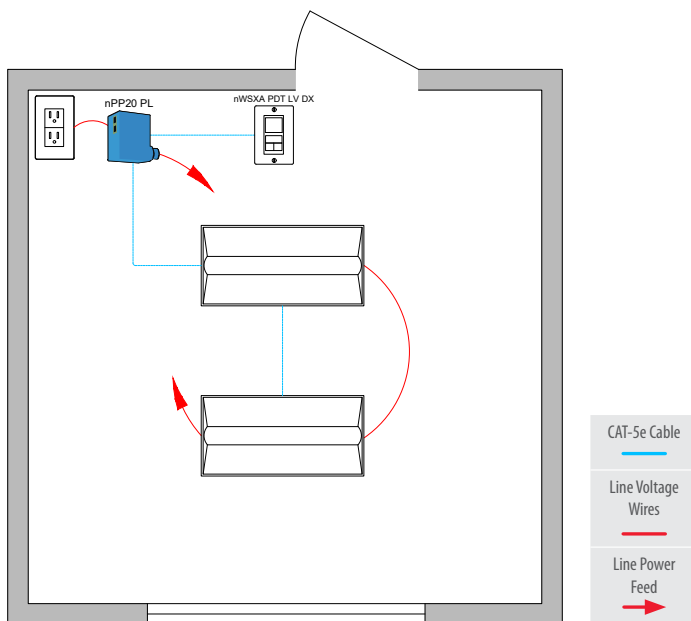

Wireless

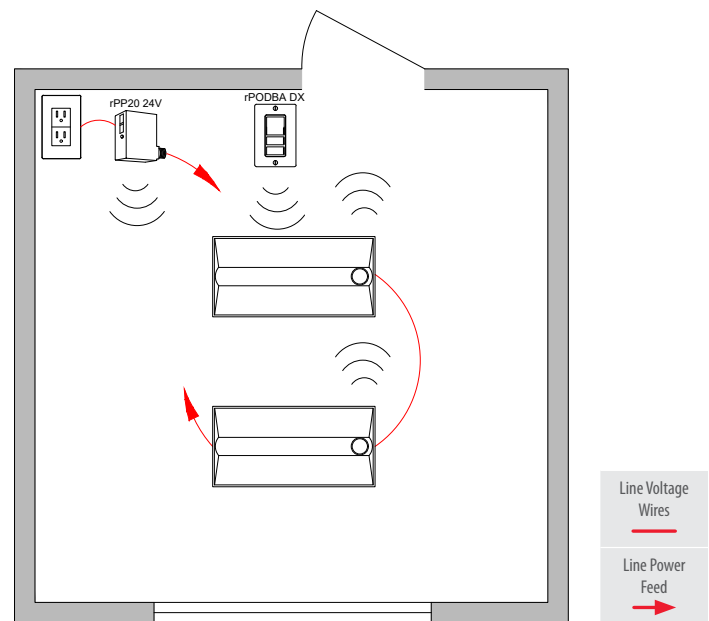

Bill of Materials

Symbol	Qty	Product #	Description
	2	See Note	Troffer with Wired Networked Embedded Controls from nLight
	1	nWSXA PDT LV DX	Wall Switch Occupancy Sensor with On/Off, Raise/Lower
	1	nPP20 PL	Plug Load Relay Pack

Bill of Materials

Symbol	Qty	Product #	Description
	2	See Note	Troffer with Wireless Networked Embedded Controls from nLight with Sensor Option
	1	rPODBA DX G2	Battery Powered, On/Off, Raise/Lower WallPod
	1	rPP20 24V EFP G2	Plug Load Relay Pack

/ OPERATIONAL DETAILS:

Light Fixtures:

- All fixtures are dimmable
- All fixtures can be controlled together or independently
- Maximum level can be task tuned to any percentage via programming

Occupancy Control:

- Fixtures must be turned on manually (or optionally can be configured to come on automatically to 50%)
- Plug-load turns on automatically
- Fixtures and plug-load turn off automatically when room becomes vacant

Daylight Control:

- Not required for offices without windows or that have loads <150W in sidelit zones

Manual Control:

- On/off & raise/lower control of fixtures

/ ADDITIONAL OPTIONS:

- Room can be connected to nLight backbone to enable network control or time schedules
- HVAC control available through system-wide BACnet® interface option on the ECLYPSE® controller
- Luminaires with wireless networked embedded controls from nLight and occupancy/daylighting sensor options available, please see the fixture specification sheet
- For emergency lighting control use a power pack with ER/EM option or luminaire with networked embedded controls from nLight with emergency option

Note: Contact your local lighting agent for more information on luminaires with networked embedded controls from nLight.

Wired

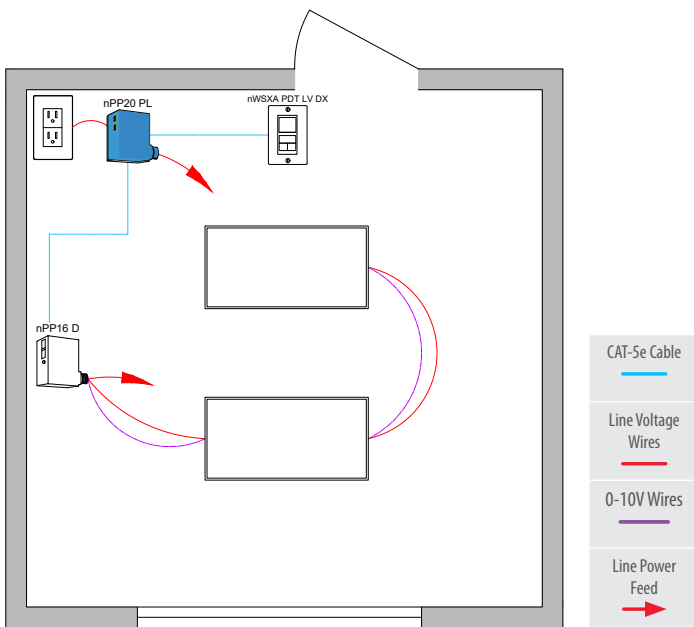

Wireless

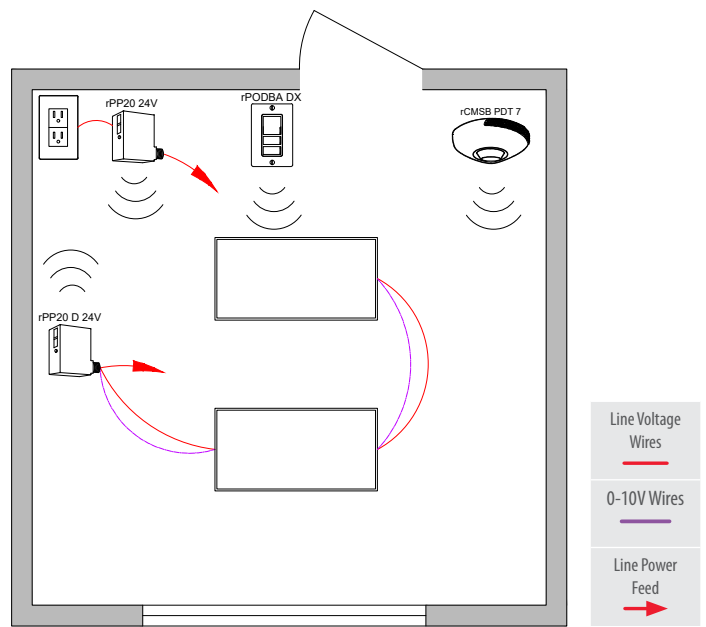

Bill of Materials

Symbol	Qty	Product #	Description
	1	nPP16 D EFP	Relay Pack with 0-10V Dimming Output
	1	nWSXA PDT LV DX	Wall Switch Occupancy Sensor with On/Off, Raise/Lower
	1	nPP20 PL	Plug Load Relay Pack

Bill of Materials

Symbol	Qty	Product #	Description
	1	rPP20 D 24V EFP G2	Relay Pack with 0-10V Dimming Output
	1	rPODBA DX G2	Battery Powered, On/Off, Raise/Lower WallPod
	1	rCMSB PDT 7 G2	Battery Powered Occupancy and Daylight Sensor
	1	rPP20 24V EFP G2	Plug Load Relay Pack

/ OPERATIONAL DETAILS:

Light Fixtures:

- All fixtures are dimmable
- All fixtures are controlled together
- Maximum level can be task tuned to any percentage via programming

Occupancy Control:

- Fixtures must be turned on manually (or optionally can be configured to come on automatically to 50%)
- Plug-load turns on automatically
- Fixtures and plug-load turn off automatically when room becomes vacant

Daylight Control:

- Not required for offices without windows or that have loads <150W in sidelit zone

Manual Control:

- On/off & raise/lower control of fixtures

/ ADDITIONAL OPTIONS:

- Room can be connected to nLight backbone to enable network control or time schedules
- HVAC control available through system-wide BACnet® interface option on the ECLYPSE® controller
- For emergency lighting control use a power pack with ER/EM option or luminaire with networked embedded controls from nLight with emergency option

Wired

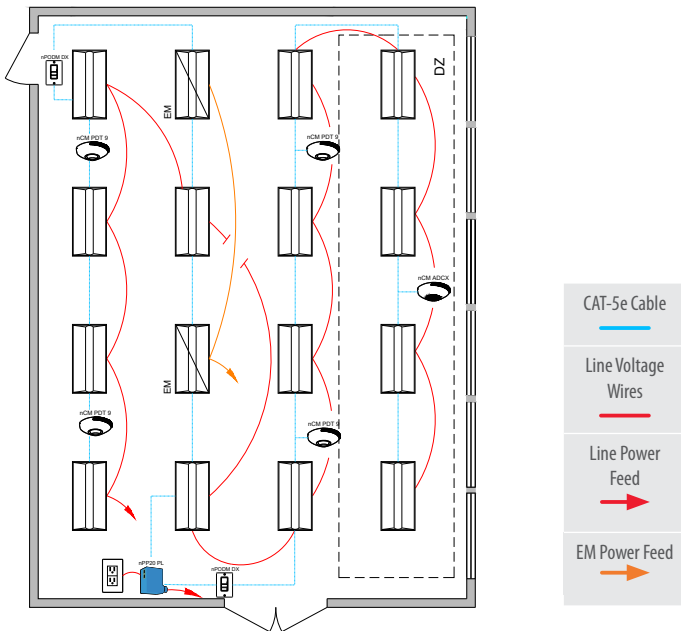

- ① Some emergency luminaires with networked embedded controls from nLight require a normal sense line connection. Wiring shown assumes battery backup emergency option. See fixture spec sheets for details.

Wireless

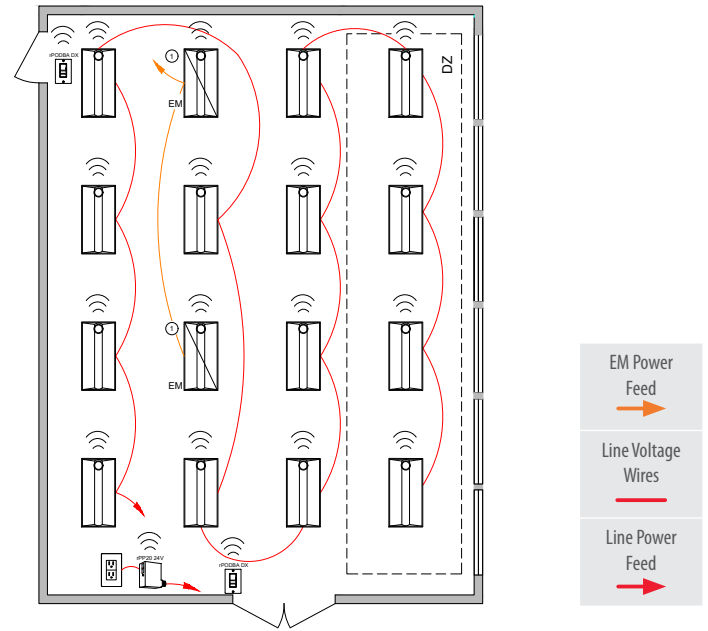

- ① Fixture(s) assumed to include power interruption detection emergency option. For battery backup option, no dedicated EM circuit necessary.

Bill of Materials

Symbol	Qty	Product #	Description
	14	See Note	Troffer with Wired Networked Embedded Controls from nLight
	2	See Note	Troffer with Wired Networked Embedded Controls from nLight with Battery Option
	2	nPODMA DX	On/Off, Raise/Lower WallPod
	4	nCM PDT 9 RJB	Occupancy Sensor
	1	nCM ADCX 1 RJB	Daylight Sensor
	1	nPP20 PL	Plug Load Relay Pack

Bill of Materials

Symbol	Qty	Product #	Description
	14	See Note	Troffer with Wireless Networked Embedded Controls from nLight with Sensor Option
	2	See Note	Troffer with Wireless Networked Embedded Controls from nLight with Sensor and Emergency Option
	2	rPODBA DX G2	Battery Powered, On/Off, Raise/Lower WallPod
	1	rPP20 24V EFP G2	Plug Load Relay Pack

OPERATIONAL DETAILS:

Light Fixtures:

- All fixtures are dimmable
- All fixtures are controlled together or independently
- Maximum level can be task tuned to any percentage via programming

Occupancy Control:

- Fixtures must be turned on manually (or optionally can be configured to come on automatically to 50%)
- Plug-load turns on automatically
- Fixtures and plug-load turn off automatically when room becomes vacant

Daylight Control:

- Smooth continuous dimming
- Custom grouping of fixtures into separate daylight zones (max. number zones = number of fixtures)
- Not required for offices without windows or that have loads <150W in sidelit zones

Manual Control:

- On/off & raise/lower control of fixtures

ADDITIONAL OPTIONS:

- Room can be connected to nLight backbone to enable network control or time schedules
- HVAC control available through system-wide BACnet® interface option on the ECLYPSE® controller
- Luminaires with wireless networked embedded controls from nLight and occupancy/daylighting sensor options available, please see the fixture specification sheet
- For emergency lighting control use a power pack with ER/EM option or luminaire with networked embedded controls from nLight with emergency option

Note: Contact your local lighting agent for more information on luminaires with networked embedded controls from nLight.

Wired

Wireless

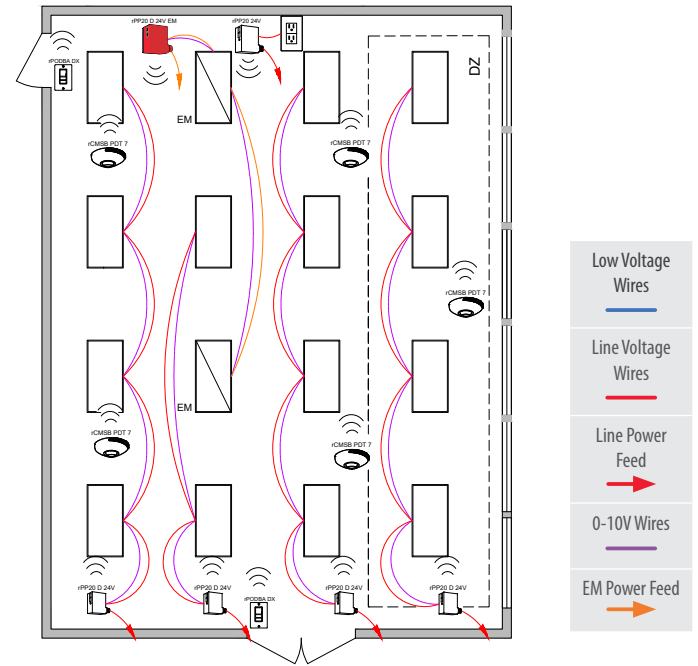
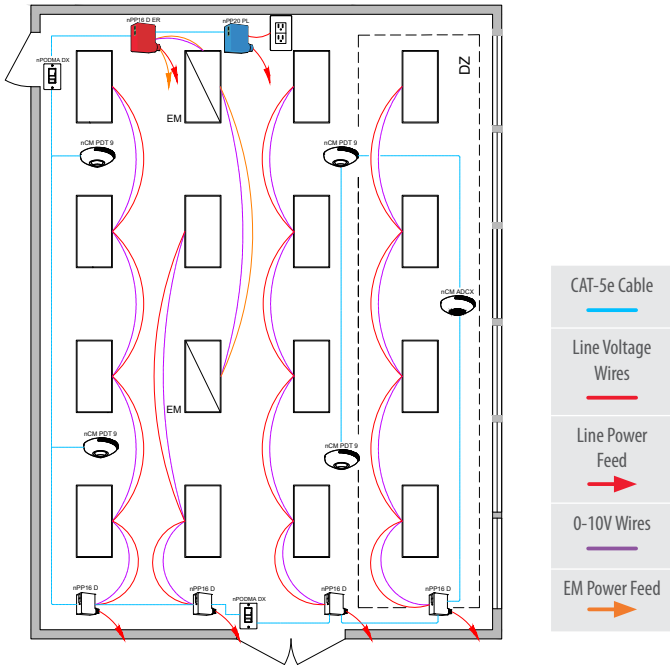

Bill of Materials

Symbol	Qty	Product #	Description
	4	nPP16 D EFP	Relay Pack with 0-10V Dimming Output
	1	nPP16 D ER EFP	Emergency Relay Pack with 0-10V Dimming Output
	2	nPODMA DX	On/Off, Raise/Lower WallPod
	4	nCM PDT 9 RJB	Occupancy Sensor
	1	nCM ADCX RJB	Daylight Sensor
	1	nPP20 PL	Plug Load Relay Pack

Bill of Materials

Symbol	Qty	Product #	Description
	4	rPP20 D 24V EFP G2	Relay Pack with 0-10V Dimming Output
	1	rPP20 D 24V EM EFP G2	Emergency Relay Pack with 0-10V Dimming Output
	2	rPODBA DX G2	Battery Powered, On/Off, Raise/Lower WallPod
	5	rCMSB PDT 7 G2	Battery Powered Occupancy and Daylight Sensor
	1	rPP20 24V EFP G2	Plug Load Relay Pack

OPERATIONAL DETAILS:

Light Fixtures:

- All fixtures are dimmable
- Each row controlled independently
- Maximum level can be task tuned to any percentage via programming

Occupancy Control:

- Fixtures must be turned on manually (or optionally can be configured to come on automatically to 50%)
- Plug-load turns on automatically
- Fixtures and plug-load turn off automatically when room becomes vacant

Daylight Control:

- Smooth continuous dimming
- Daylight zones defined by rows
- Not required for offices without windows or that have loads <150W in sidelit zones

Manual Control:

- On/off & raise/lower control of fixtures

ADDITIONAL OPTIONS:

- Room can be connected to nLight backbone to enable network control or time schedules
- HVAC control available through system-wide BACnet® interface option on the ECLYPSE® controller
- For emergency lighting control use a power pack with ER/EM option or luminaire with networked embedded controls from nLight with emergency option

Wired

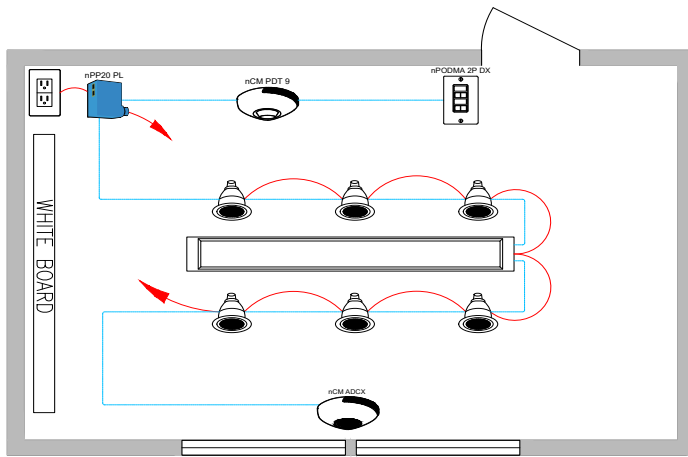

Wireless

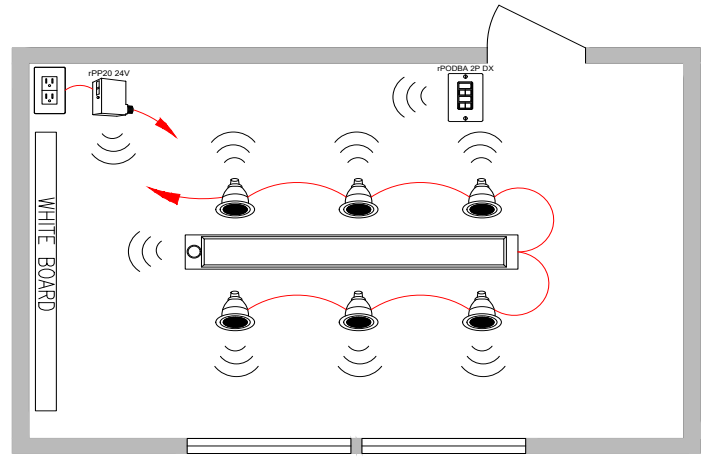

Bill of Materials

Symbol	Qty	Product #	Description
	1	See Note	Luminaire with Wired Networked Embedded Controls from nLight
	6	See Note	Downlight with Wired Networked Embedded Controls from nLight
	1	nPODMA 2P DX	2-Pole, On/Off, Raise/Lower WallPod
	1	nCM PDT 9 RJB	Occupancy Sensor
	1	nCM ADCX RJB	Daylight Sensor
	1	nPP20 PL	Plug Load Relay Pack

Bill of Materials

Symbol	Qty	Product #	Description
	1	See Note	Luminaire with Wireless Networked Embedded Controls from nLight with Sensor Option
	6	See Note	Downlight with Wireless Networked Embedded Controls from nLight
	1	rPODBA 2P DX G2	Battery Powered, 2-Pole, On/Off, Raise/Lower WallPod
	1	rPP20 24V EFP G2	Plug Load Relay Pack

/ OPERATIONAL DETAILS:

Light Fixtures:

- All fixtures are dimmable
- Maximum level can be task tuned to any percentage via programming
- A/V zone can be programmed to control two fixtures in front of the whiteboard

Occupancy Control:

- Fixtures must be turned on manually (or optionally can be configured to come on automatically to 50%)
- Plug-load turns on automatically
- Fixtures and plug-load turn off automatically when room becomes vacant

Daylight Control:

- Smooth continuous dimming
- Custom grouping of fixtures into separate daylight zones (max number zones = number of fixtures)
- Not required for areas without windows or that have loads <150w in sidelit zones

Manual Control:

- On/off & raise lower control of two zones of fixtures

/ ADDITIONAL OPTIONS:

- Room can be connected to nLight backbone to enable network control or time schedules
- HVAC control available through system-wide BACnet® interface option on the ECLYPSE® controller
- Luminaires with wireless networked embedded controls from nLight and occupancy/daylighting sensor options available, please see the fixture specification sheet
- For emergency lighting control use a power pack with ER/EM option or luminaire with networked embedded controls from nLight with emergency option

Note: Contact your local lighting agent for more information on luminaires with networked embedded controls from nLight.

Wired

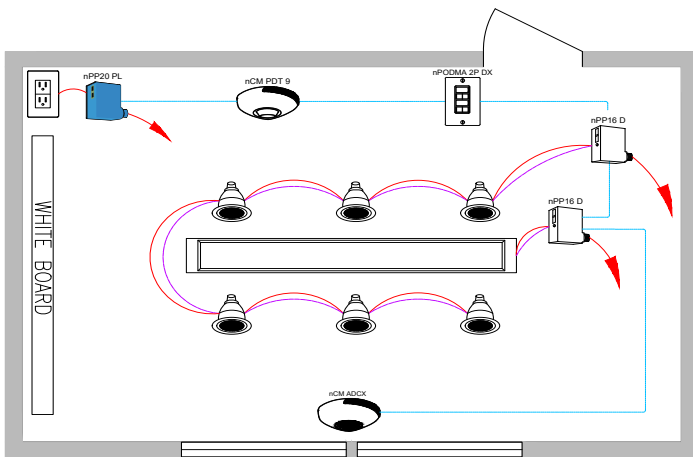

Wireless

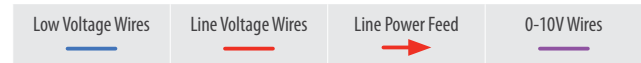
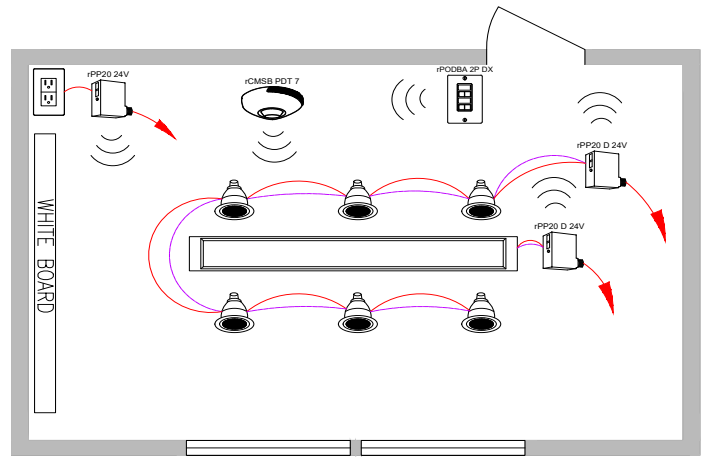

Bill of Materials

Symbol	Qty	Product #	Description
	2	nPP16 D EFP	Relay Pack with 0-10V Dimming Output
	1	nPODMA 2P DX	2-Pole, On/Off, Raise/Lower WallPod
	1	nCM PDT 9 RJB	Occupancy Sensor
	1	nCM ADCX RJB	Daylight Sensor
	1	nPP20 PL	Plug Load Relay Pack

Bill of Materials

Symbol	Qty	Product #	Description
	2	rPP20 D 24V EFP G2	Relay Pack with 0-10V Dimming Output
	1	rPODBA 2P DX G2	Battery Powered, 2-Pole, On/Off, Raise/Lower WallPod
	1	rCMSB PDT 7 G2	Battery Powered Occupancy and Daylight Sensor
	1	rPP20 24V EFP G2	Plug Load Relay Pack

OPERATIONAL DETAILS:

Light Fixtures:

- All fixtures are dimmable
- Maximum level can be task tuned to any percentage via programming

Occupancy Control:

- Fixtures must be turned on manually (or optionally can be configured to come on automatically to 50%)
- Plug-load turns on automatically
- Fixtures and plug-load turn off automatically when room becomes vacant

Daylight Control:

- Smooth continuous dimming
- Daylight zones defined by rows
- Not required for areas without windows or that have loads <150W in sidelit zones

Manual Control:

- On/off & raise lower control of two zones of fixtures

ADDITIONAL OPTIONS:

- Room can be connected to nLight backbone to enable network control or time schedules
- HVAC control available through system-wide BACnet® interface option on the ECLYPSE® controller
- For emergency lighting control use a power pack with ER/EM option or luminaire with networked embedded controls from nLight with emergency option

Wired

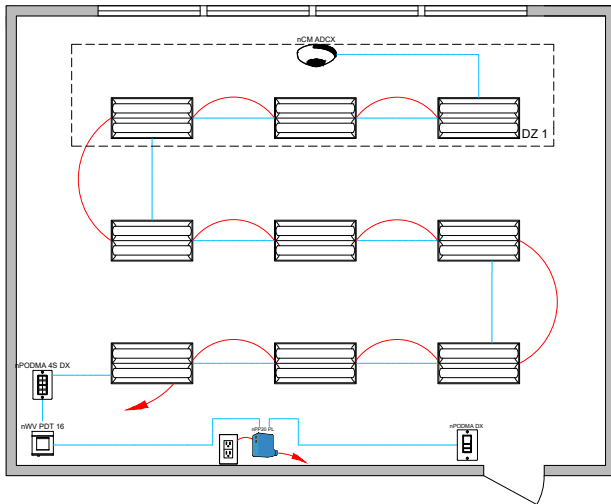

Wireless

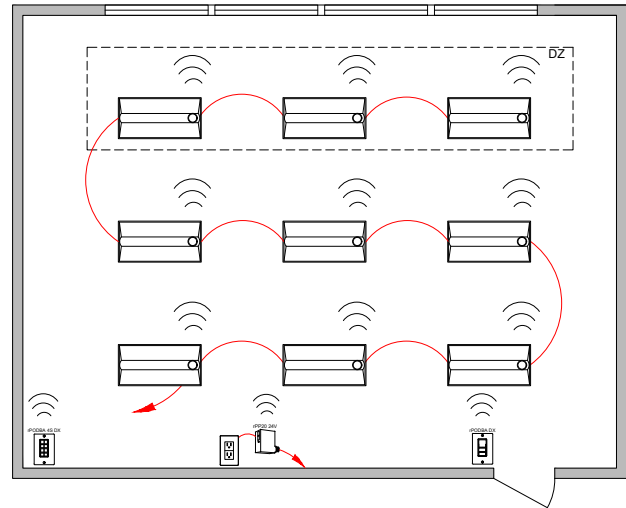

Bill of Materials

Symbol	Qty	Product #	Description
	9	See Note	Troffer with Wired Networked Embedded Controls from nLight
	1	nPODMA DX	On/Off, Raise/Lower WallPod
	1	nWV PDT 16	Dual Technology Wide View Occupancy Sensor
	1	nPODMA 4S DX	Teacher Station — 4 Scene Control with Master On/Off & Raise/Lower
	1	nCM ADCX RJB	Daylight Sensor
	1	nPP20 PL	Plug Load Relay Pack

Bill of Materials

Symbol	Qty	Product #	Description
	9	See Note	Troffer with Wireless Networked Embedded Controls from nLight with Sensor Option
	1	rPODBA DX G2	Battery Powered, On/Off, Raise/Lower WallPod
	1	rPODBA 4S DX G2	Teacher Station — Battery Powered 4 Scene Control with Master On/Off & Raise/Lower
	1	rPP20 24V EFP G2	Plug Load Relay Pack

/ OPERATIONAL DETAILS:

Light Fixtures:

- All fixtures are dimmable
- All fixtures are controlled together or independently
- Maximum level can be task tuned to any percentage via programming

Occupancy Control:

- Fixtures must be turned on manually (or optionally can be configured to some on automatically to 50%)
- Plug-load turns on automatically
- Fixtures and plug-load turn off automatically when room becomes vacant

Daylight Control:

- Smooth continuous dimming
- Custom grouping of fixtures into separate daylight zones (max number zones = number of fixtures)
- Not required for areas without windows or that have loads <150W in sidelit zones

Manual Control:

- On/off & raise/lower control of entire room
- Teacher station with 4 preset scenes

/ ADDITIONAL OPTIONS:

- Room can be connected to nLight backbone to enable network control or time schedules
- HVAC control available through system-wide BACnet® interface option on the ECLYPSE controller
- Luminaires with wireless networked embedded controls from nLight and occupancy/daylighting sensor options available, please see the fixture specification sheet
- For emergency lighting control use a power pack with ER/EM option or luminaire with networked embedded controls from nLight with emergency option

Note: Contact your local lighting agent for more information on luminaires with networked embedded controls from nLight.

Wired

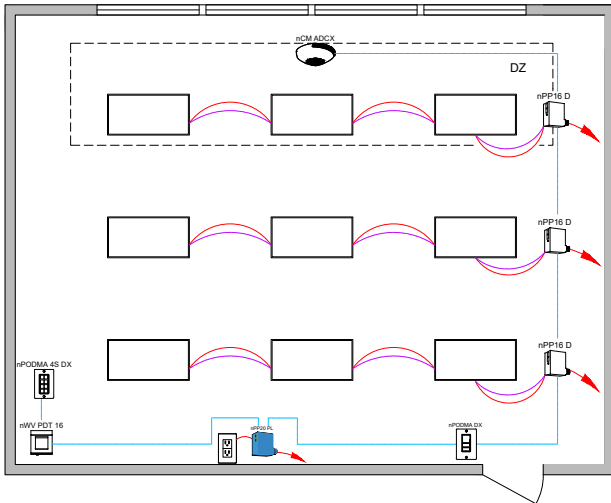

Wireless

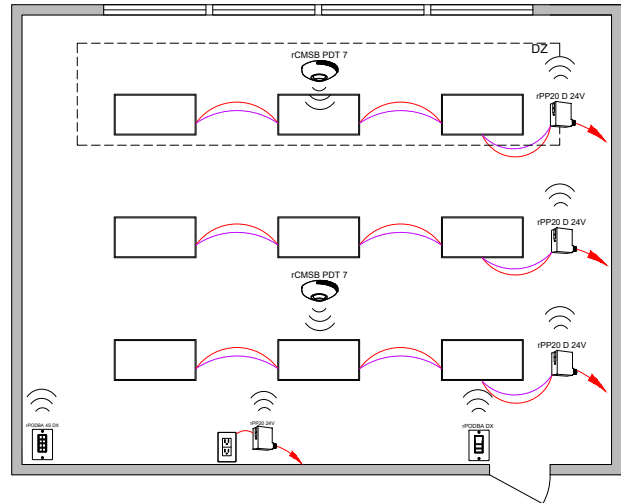

Bill of Materials

Symbol	Qty	Product #	Description
	3	nPP16 D EFP	Relay Module with 0-10V Dimming Output
	1	nPODMA DX	On/Off, Raise/Lower WallPod
	1	nWV PDT 16	Dual Technology Wide View Occupancy Sensor
	1	nPODMA 4S DX	Teacher Station — 4 Scene Control with Master On/Off & Raise/Lower
	1	nCM ADCX RJB	Daylight Sensor
	1	nPP20 PL	Plug Load Relay Pack

Bill of Materials

Symbol	Qty	Product #	Description
	3	rPP20 D 24V EFP G2	Relay Pack with 0-10V Dimming Output
	1	rPODBA DX G2	Battery Powered, On/Off, Raise/Lower WallPod
	2	rCMSB PDT 7 G2	Battery Powered Occupancy and Daylight Sensor
	1	rPODBA 4S DX G2	Teacher Station — Battery Powered 4 Scene Control with Master On/Off & Raise/Lower
	1	rPP20 24V EFP G2	Plug Load Relay Pack

OPERATIONAL DETAILS:

Light Fixtures:

- All fixtures are dimmable
- Each row can be controlled independently
- Maximum level can be task tuned to any percentage via programming

Occupancy Control:

- Fixtures must be turned on manually (or optionally can be configured to come on automatically to 50%)
- Plug-load turns on automatically
- Fixtures and plug-load turn off automatically when room becomes vacant

Daylight Control:

- Smooth continuous dimming
- Daylight zones defined by rows
- Not required for areas without windows or that have loads <150W in sidelit zones

Manual Control:

- Master on/off & raise/lower control of entire room
- Teacher station with 4 preset scenes

ADDITIONAL OPTIONS:

- Room can be connected to nLight backbone to enable network control or time schedules
- HVAC control available through system-wide BACnet® interface option on the ECLYPSE® controller
- For emergency lighting control use a power pack with ER/EM option or luminaire with networked embedded controls from nLight with emergency option

Wired

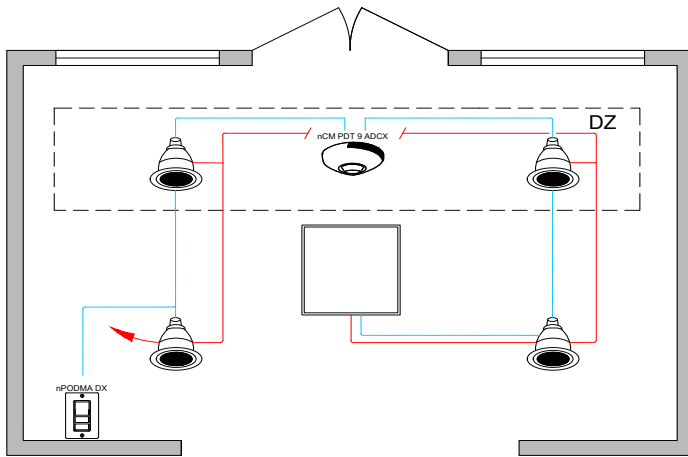

CAT-5e Cable

Line Voltage Wires

Line Power Feed

Wireless

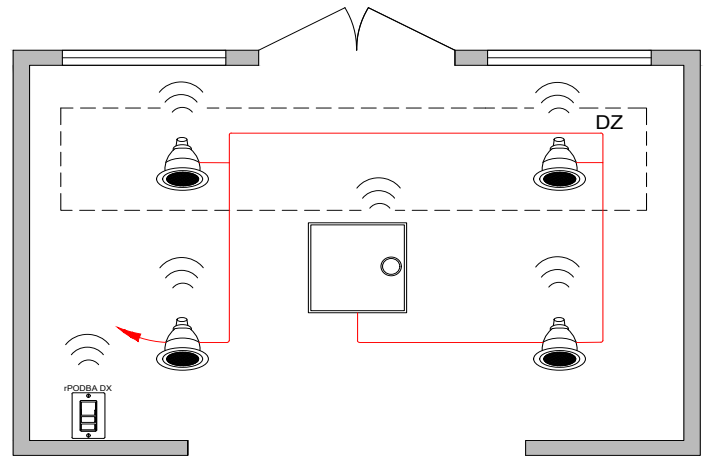

Line Voltage Wires

Line Power Feed

Bill of Materials

Symbol	Qty	Product #	Description
	4	See Notes	Downlight with Wired Networked Embedded Controls from nLight
	1	See Notes	Troffer with Wired Networked Embedded Controls from nLight
	1	nPODMA DX	On/Off, Raise/Lower WallPod
	1	nCM PDT 9 ADCX RJB	Occupancy and Daylight Sensor

Bill of Materials

Symbol	Qty	Product #	Description
	4	See Notes	Downlight with Wireless Networked Embedded Controls from nLight
	1	See Notes	Troffer with Wireless Networked Embedded Controls from nLight with Sensor Option
	1	rPODBA DX G2	Battery Powered, On/Off, Raise/Lower WallPod

/ OPERATIONAL DETAILS:

Light Fixtures:

- All fixtures are dimmable
- All fixtures are controlled together or independently
- Maximum level can be task tuned to any percentage via programming

Occupancy Control:

- Fixtures automatically go to full bright when occupied
- Fixtures automatically turn off when room becomes vacant

Daylight Control:

- Smooth continuous dimming
- Custom grouping of fixtures into separate daylight zones (max number zones = number of fixtures)
- Not required for areas without windows or that have loads <150W in sidelit zones

Manual Control:

- On/off & raise/lower control of fixtures

/ ADDITIONAL OPTIONS:

- Room can be connected to nLight backbone to enable network control or time schedules
- HVAC control available through system-wide BACnet® interface option on the ECLYPSE controller
- Luminaires with wireless networked embedded controls from nLight and occupancy/daylighting sensor options available, please see the fixture specification sheet
- For emergency lighting control use a power pack with ER/EM option or luminaire with networked embedded controls from nLight with emergency option

Note: Contact your local lighting agent for more information on luminaires with networked embedded controls from nLight.

Wired

Wireless

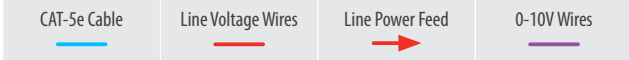
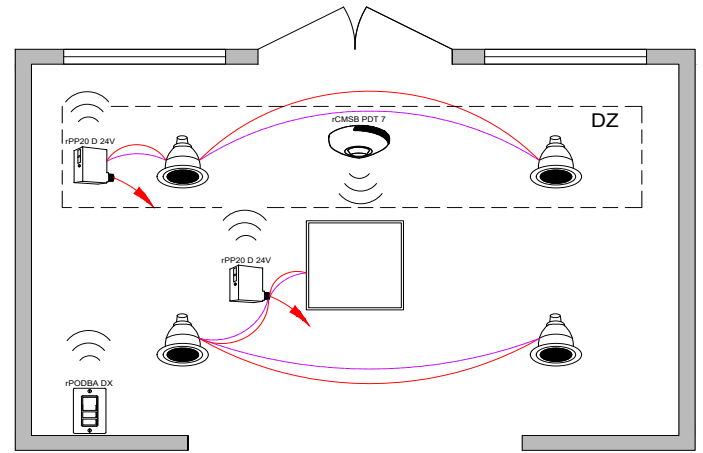
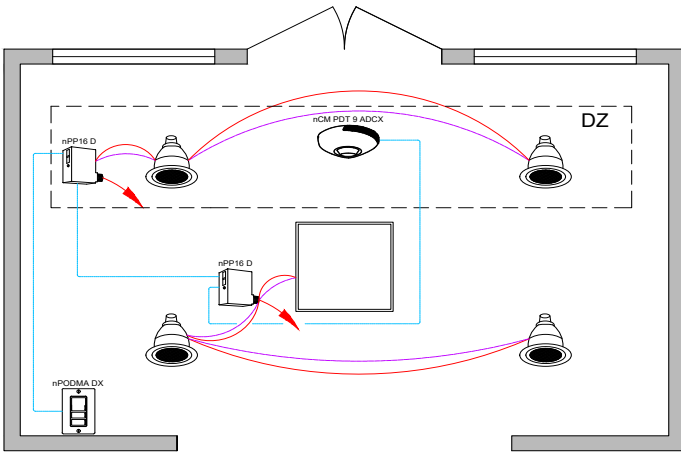

Bill of Materials

Bill of Materials

Symbol	Qty	Product #	Description
	2	nPP16 D EFP	Relay Pack with 0-10V Dimming Output
	1	nPODMA DX	On/Off, Raise/Lower WallPod
	1	nCM PDT 9 ADCX RJB	Occupancy and Daylight Sensor

Symbol	Qty	Product #	Description
	2	rPP20 D 24V EFP G2	Relay Pack with 0-10V Dimming Output
	1	rPODBA DX G2	Battery Powered, On/Off, Raise/Lower WallPod
	1	rCMSB PDT 7 G2	Battery Powered Occupancy and Daylight Sensor

OPERATIONAL DETAILS:

ADDITIONAL OPTIONS:

Light Fixtures:

- All fixtures are dimmable
- Maximum level can be task tuned to any percentage via programming

Occupancy Control:

- Fixtures automatically go to full bright when occupied
- Fixtures automatically turn off when room becomes vacant

Daylight Control:

- Smooth continuous dimming
- Daylight zones defined by relay module wiring
- Not required for areas without windows or that have loads <150W in sidelit zones

Manual Control:

- On/off & raise/lower control of fixtures

- Room can be connected to nLight backbone to enable network control or time schedules
- HVAC control available through system-wide BACnet® interface option on the ECLYPSE® controller
- For emergency lighting control use a power pack with ER/EM option or luminaire with networked embedded controls from nLight with emergency option

Wired

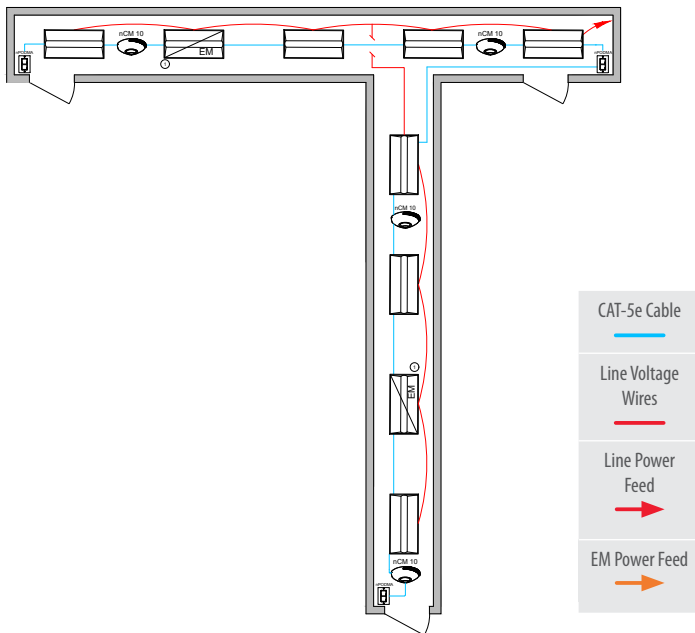

- ① Some emergency luminaires with networked embedded controls from nLight require a normal sense line connection. Wiring shown assumes battery backup emergency option. See fixture spec sheets for details.

Bill of Materials

Symbol	Qty	Product #	Description
	7	See Note	Troffer with Wired Networked Embedded Controls from nLight with Sensor Option
	2	See Note	Troffer with Wired Networked Embedded Controls from nLight with Battery Option
	3	nPODMA	On/Off WallPod
	4	nCM 10 RJB	Occupancy Sensor

Wireless

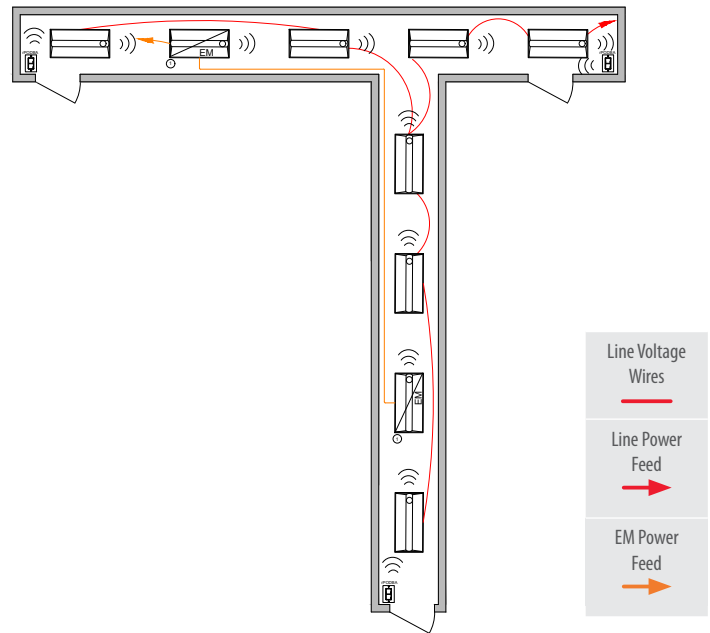

- ① Fixture(s) assumed to include power interruption detection emergency option. For battery backup option, no dedicated EM circuit necessary.

Bill of Materials

Symbol	Qty	Product #	Description
	7	See Note	Troffer with Wireless Networked Embedded Controls from nLight with Sensor Option
	2	See Note	Troffer with Wireless Networked Embedded Controls from nLight with Sensor and Emergency Option
	3	rPODBA G2	Battery Powered, On/Off WallPod

/ OPERATIONAL DETAILS:

Light Fixtures:

- All fixtures are dimmable
- All fixtures are controlled together or independently
- Maximum level can be task tuned to any percentage via programming

Occupancy Control:

- Fixtures automatically go to full bright when occupied
- Fixtures automatically turn off or optionally can be configured to drop to low dim setting when space becomes vacant

Daylight Control:

- Not required for areas without windows or that have loads <150W in sidelit zones

Manual Control:

- On/off control of fixtures

/ ADDITIONAL OPTIONS:

- Room can be connected to nLight backbone to enable network control or time schedules
- HVAC control available through system-wide BACnet® interface option on the ECLYPSE controller
- Luminaires with wireless networked embedded controls from nLight and occupancy/daylighting sensor options available, please see the fixture specification sheet
- For emergency lighting control use a power pack with ER/EM option or luminaire with networked embedded controls from nLight with emergency option

Note: Contact your local lighting agent for more information on luminaires with networked embedded controls from nLight.



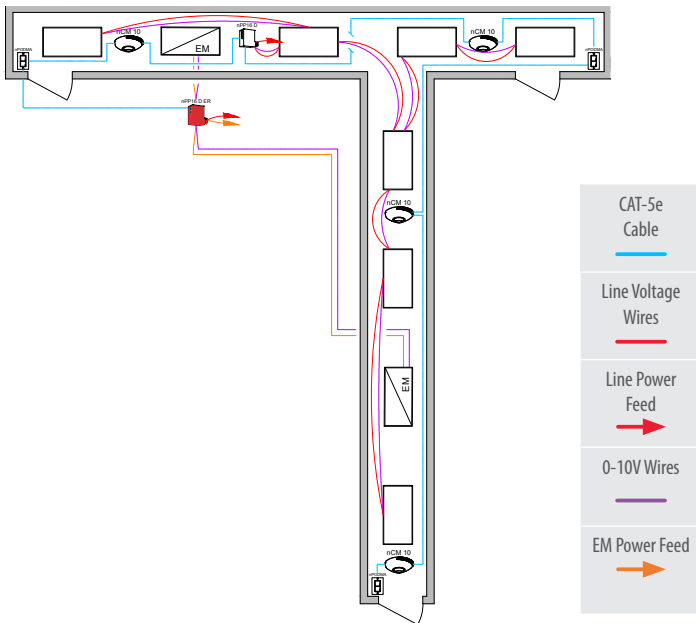

Wired

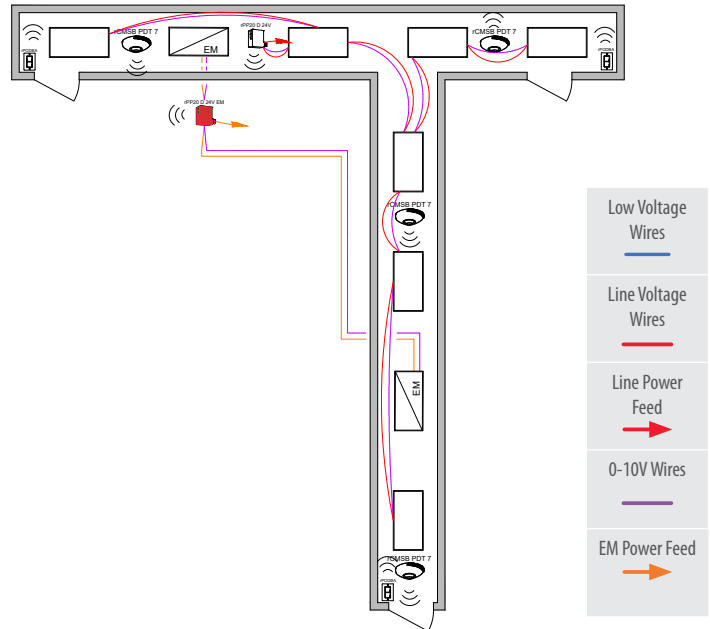





Wireless



Bill of Materials

Symbol	Qty	Product #	Description
	1	nPP16 D EFP	Relay Pack with 0-10V Dimming Output
	1	nPP16 D ER EFP	Emergency Relay Pack with 0-10V Dimming Output
	4	nCM 10 RJB	Occupancy Sensor
	3	nPODMA	On/Off WallPod

Bill of Materials

Symbol	Qty	Product #	Description
	1	rPP20 D 24V EFP G2	Relay Pack with 0-10V Dimming Output
	1	rPP20 D 24V EM EFP G2	Emergency Relay Pack with 0-10V Dimming Output
	4	rCMSB PDT 7 G2	Battery Powered Occupancy Sensor
	3	rPODBA G2	Battery Powered, On/Off WallPod

/ OPERATIONAL DETAILS:

Light Fixtures:

- All fixtures are dimmable
- Maximum level can be task tuned to any percentage via programming

Occupancy Control:

- Fixtures automatically go to full bright when occupied
- Fixtures automatically turn off or optionally can be configured to drop to low dim setting when space becomes vacant

Daylight Control:

- Not required for areas without windows or that have loads <150W in sidelit zones

Manual Control:

- On/off control of fixtures

/ ADDITIONAL OPTIONS:

- Room can be connected to nLight backbone to enable network control or time schedules
- HVAC control available through system-wide BACnet® interface option on the ECLYPSE controller
- For emergency lighting control use a power pack with ER/EM option or luminaire with networked embedded controls from nLight with emergency option

Wired

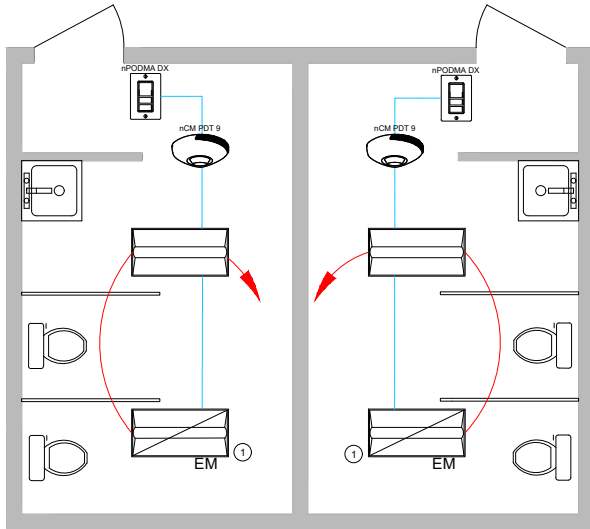

① Some emergency luminaires with networked embedded controls from nLight require a normal sense line connection. Wiring shown assumes battery backup emergency option. See fixture spec sheets for details.



Wireless

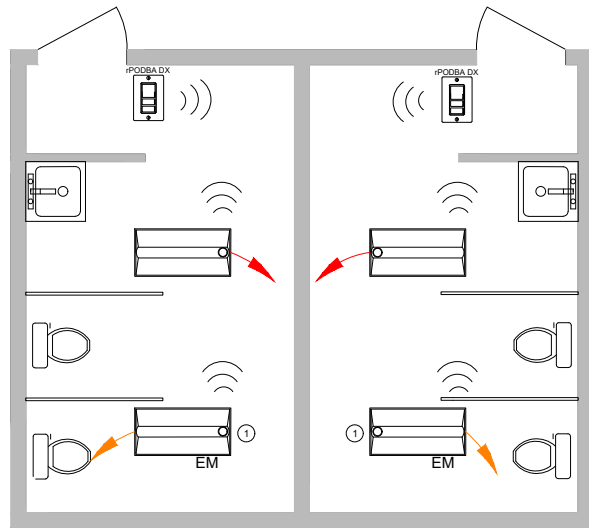

① Fixture(s) assumed to include power interruption detection emergency option. For battery backup option, no dedicated EM circuit necessary.



Bill of Materials

Symbol	Qty	Product #	Description
	2	See Note	Troffer with Wired Networked Embedded Controls from nLight
	2	See Note	Troffer with Wired Networked Embedded Controls from nLight with Battery Option
	2	nPODMA DX	On/Off, Raise/Lower WallPod
	2	nCM PDT 9 RJB	Occupancy Sensor

Bill of Materials

Symbol	Qty	Product #	Description
	2	See Note	Troffer with Wireless Networked Embedded Controls from nLight with Sensor Option
	2	See Note	Troffer with Wireless Networked Embedded Controls from nLight with Sensor and Emergency Option
	2	nPODBA DX G2	Battery Powered, On/Off, Raise/Lower WallPod

OPERATIONAL DETAILS:

Light Fixtures:

- All fixtures are dimmable
- All fixtures are controlled together or independently (per room)
- Maximum level can be task tuned to any percentage via programming

Occupancy Control:

- Fixtures automatically go to full bright when occupied (or optionally can be configured to come on automatically to 50%)
- Fixtures automatically turn off or optionally can be configured to drop to low dim setting when space becomes vacant

Manual Control:

- On/off & raise/lower control of fixtures
- If switch poses safety concerns, optionally can be programmed for "on only"

ADDITIONAL OPTIONS:

- Room can be connected to nLight backbone to enable network control or time schedules
- HVAC control available through system-wide BACnet® interface option on the ECLYPSE® controller
- Fixture embedded control and occupancy/daylighting sensor options available, please see the fixture specification sheet
- For emergency lighting control use a power pack with ER/EM option or luminaire with networked embedded controls from nLight with emergency option

Note: Contact your local lighting agent for more information on luminaires with networked embedded controls from nLight.

Wired

Wireless

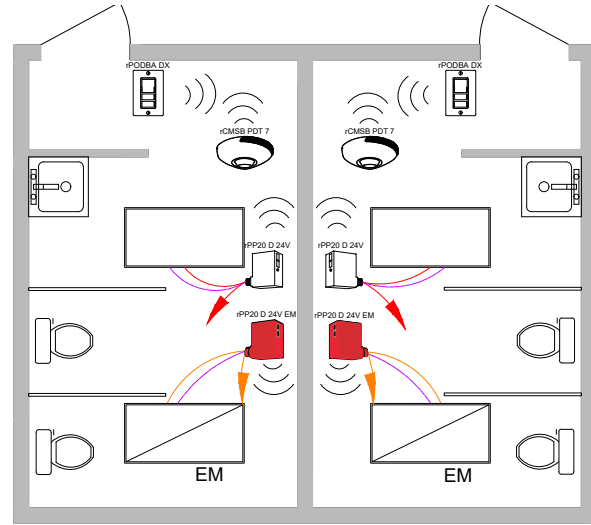
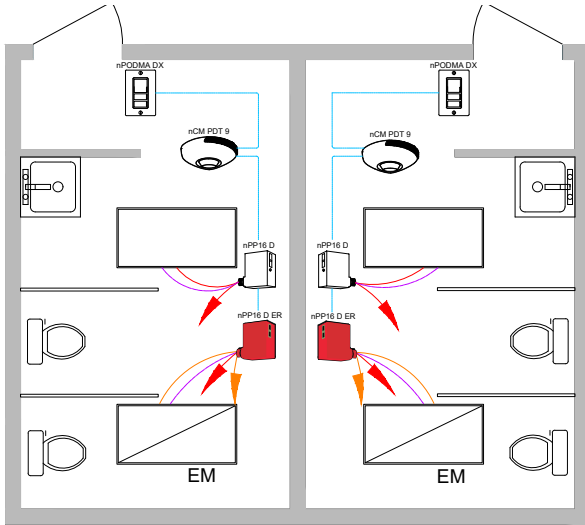

Bill of Materials

Symbol	Qty	Product #	Description
	2	nPP16 D EFP	Relay Pack with 0-10V Dimming Output
	2	nPP16 D ER EFP	Emergency Module with 0-10V Dimming Output
	2	nPODMA DX	On/Off & Raise/Lower WallPod
	2	nCM PDT 9 RJB	Occupancy Sensor

Bill of Materials

Symbol	Qty	Product #	Description
	2	rPP20 D 24V EFP G2	Relay Pack with 0-10V Dimming Output
	2	rPP20 D 24V EM EFP G2	Emergency Relay Pack with 0-10V Dimming Output
	2	rPODBA DX G2	Battery Powered, On/Off & Raise/Lower WallPod
	2	rCMSB PDT 7 G2	Battery Powered Occupancy Sensor

OPERATIONAL DETAILS:

Light Fixtures:

- All fixtures are dimmable
- Maximum level can be task tuned to any percentage via programming

Occupancy Control:

- Fixtures automatically go to full bright when occupied (or optionally can be configured to come on automatically to 50%)
- Fixtures automatically turn off or optionally can be configured to drop to low dim setting when space becomes vacant

Manual Control:

- On/off & raise/lower control of fixtures
- If switch poses safety concerns, optionally can be programmed for "on only"

ADDITIONAL OPTIONS:

- Room can be connected to nLight backbone to enable network control or time schedules
- HVAC control available through system-wide BACnet® interface option on the ECLYPSE® controller
- Luminaires with wireless networked embedded controls from nLight and occupancy/daylighting sensor options available, please see the fixture specification sheet
- For emergency lighting control use a power pack with ER/EM option or luminaire with networked embedded controls from nLight with emergency option

Luminaires with Wireless Networked Embedded Controls from nLight

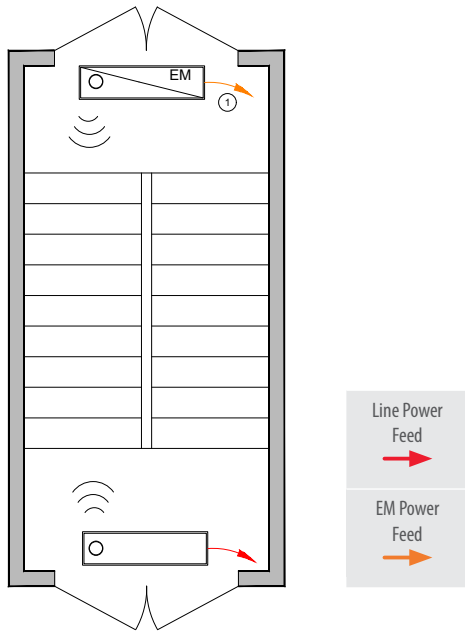

① Fixture(s) assumed to include power interruption detection emergency option. For battery backup option, no dedicated EM circuit necessary.

Wireless with 0-10V Dimming Fixtures

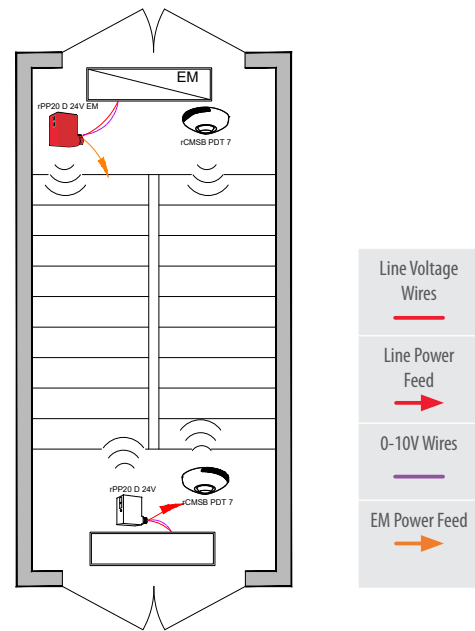

Bill of Materials

Symbol	Qty	Product #	Description
	1	See Note	Luminaire with Wireless Networked Embedded Controls from nLight with Sensor Option
	1	See Note	Luminaire with Wireless Networked Embedded Controls from nLight with Sensor and Emergency Option

Bill of Materials

Symbol	Qty	Product #	Description
	1	rPP20 D 24V EFP G2	Relay Pack with 0-10V Dimming Output
	1	rPP20 D 24V EM EFP G2	Emergency Relay Pack with 0-10V Dimming Output
	2	rCMSB PDT 7 G2	Battery Powered Occupancy Sensor

OPERATIONAL DETAILS:

Light Fixtures:

- All fixtures are dimmable
- Maximum level can be task tuned to any percentage via programming

Occupancy Control:

- Fixtures automatically go to full bright when occupied
- Fixtures automatically turn off or optionally can be configured to drop to low dim setting when space becomes vacant

Manual Control:

- Safety may preclude the use of a manual control in these areas

Note: Contact your local lighting agent for more information on luminaires with networked embedded controls from nLight.

ADDITIONAL OPTIONS:

- Room can be connected to nLight backbone to enable network control or time schedules
- HVAC control available through system-wide BACnet® interface option on the ECLYPSE® controller
- Luminaires with wireless networked embedded controls from nLight and occupancy/daylighting sensor options available, please see the fixture specification sheet
- For emergency lighting control use a power pack with ER/EM option or luminaire with networked embedded controls from nLight with emergency option

Luminaires with Wireless Networked Embedded Controls from nLight

Wireless with 0-10V Dimming Fixtures

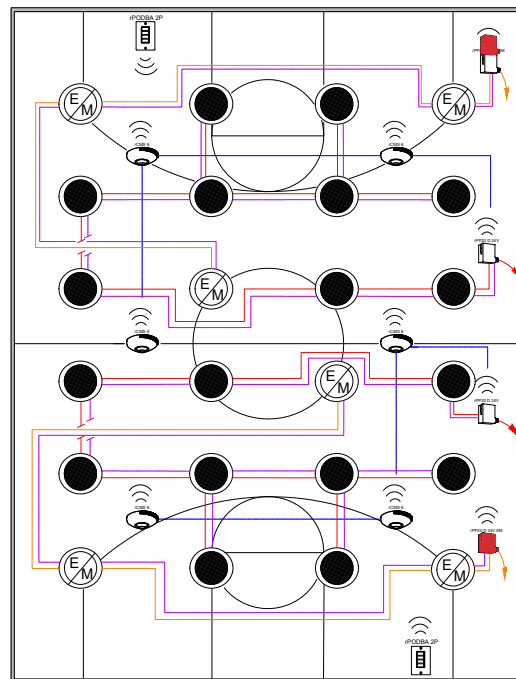
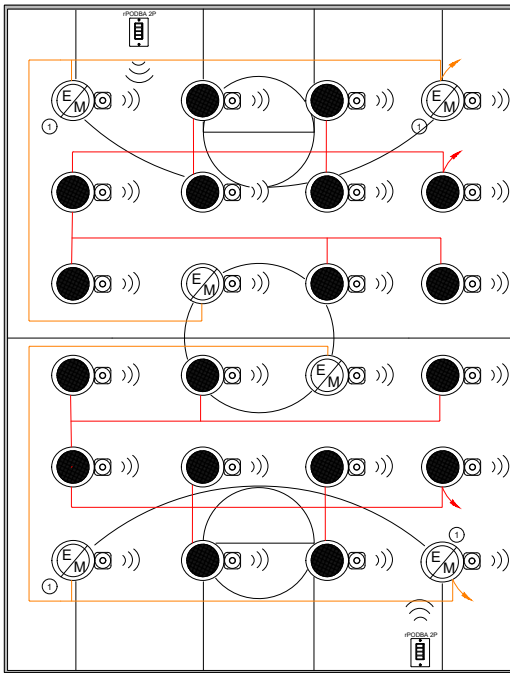

① Fixture(s) assumed to include power interruption detection emergency option. For battery backup option, no dedicated EM circuit necessary.



Bill of Materials

Symbol	Qty	Product #	Description
	18	See Notes	Luminaire with Wireless Networked Embedded Controls from nLight with Sensor Option
	6	See Notes	Luminaire with Wireless Networked Embedded Controls from nLight with Sensor and Emergency Option
	2	rPODBA 2P G2	Battery Powered, 2-Pole, On/Off WallPod

Bill of Materials

Symbol	Qty	Product #	Description
	2	rPP20 D 24V EFP G2	Relay Pack with 0-10V Dimming Output
	2	rPP20 D 24V EM EFP G2	Emergency Relay Pack with 0-10V Dimming Output
	2	rPODBA 2P G2	Battery Powered, 2-Pole, On/Off WallPod
	6	rCMS 6 G2	High Bay Occupancy Sensor

OPERATIONAL DETAILS:

Light Fixtures:

- All fixtures are dimmable
- Maximum level can be task tuned to any percentage via programming

Occupancy Control:

- Fixtures automatically go to full bright when occupied
- Fixtures automatically turn off or optionally can be configured to drop to low dim setting when space becomes vacant

Daylight Control:

- Daylight responsive controls lights to full off when adequate daylight present
- Not required for spaces without skylights or that have loads <150W in toplight zones

ADDITIONAL OPTIONS:

- Room can be connected to nLight backbone to enable network control or time schedules
- HVAC control available through system-wide BACnet® interface option on the ECLYPSE® controller
- Luminaires with wireless networked embedded controls from nLight and occupancy/daylighting sensor options available, please see the fixture specification sheet
- For emergency lighting control use a power pack with ER/EM option or luminaire with networked embedded controls from nLight with emergency option

Note: Contact your local lighting agent for more information on luminaires with networked embedded controls from nLight.

Luminaires with Wireless Networked Embedded Controls from nLight

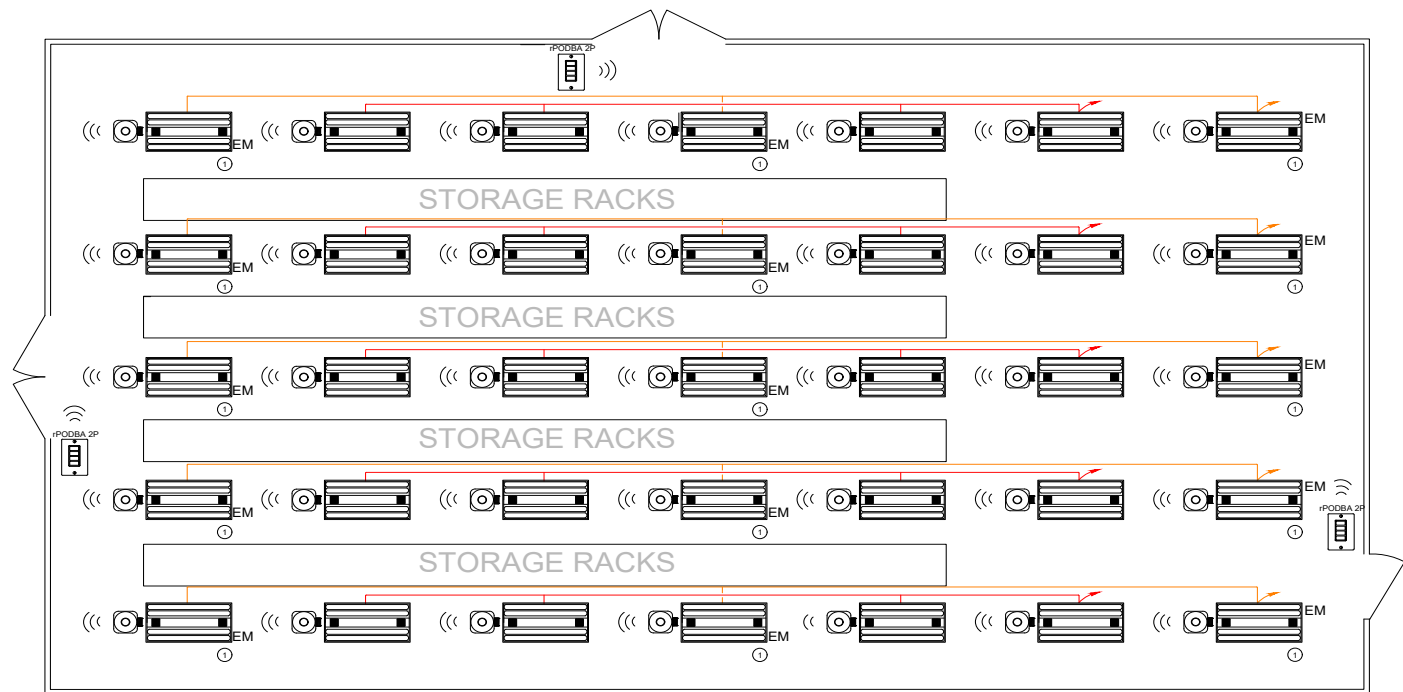

① Fixture(s) assumed to include power interruption detection emergency option. For battery backup option, no dedicated EM circuit necessary.



Bill of Materials

Symbol	Qty	Product #	Description
	20	See Note	High Bay with Wireless Networked Embedded Controls from nLight with Sensor Option
	15	See Note	High Bay with Wireless Networked Embedded Controls from nLight with Sensor and Emergency Option
	3	rPODBA 2P G2	Battery Powered, 2-Pole, On/Off WallPod

/ OPERATIONAL DETAILS:

Light Fixtures:

- All fixtures are dimmable
- Maximum level can be task tuned to any percentage via programming

Occupancy Control:

- Fixtures automatically go to full bright when occupied
- Fixtures automatically turn off or optionally can be configured to drop to low dim setting when space becomes vacant

Daylight Control:

- Daylight responsive controls lights to full off when adequate daylight present
- Not required for spaces without skylights or that have loads <150W in toplit zones

Note: Contact your local lighting agent for more information on luminaires with networked embedded controls from nLight.

/ ADDITIONAL OPTIONS:

- Room can be connected to nLight backbone to enable network control or time schedules
- HVAC control available through system-wide BACnet® interface option on the ECLYPSE® controller
- Luminaires with wireless networked embedded controls from nLight and occupancy/daylighting sensor options available, please see the fixture specification sheet
- For emergency lighting control use a power pack with ER/EM option or luminaire with networked embedded controls from nLight with emergency option

Wireless Parking Garage

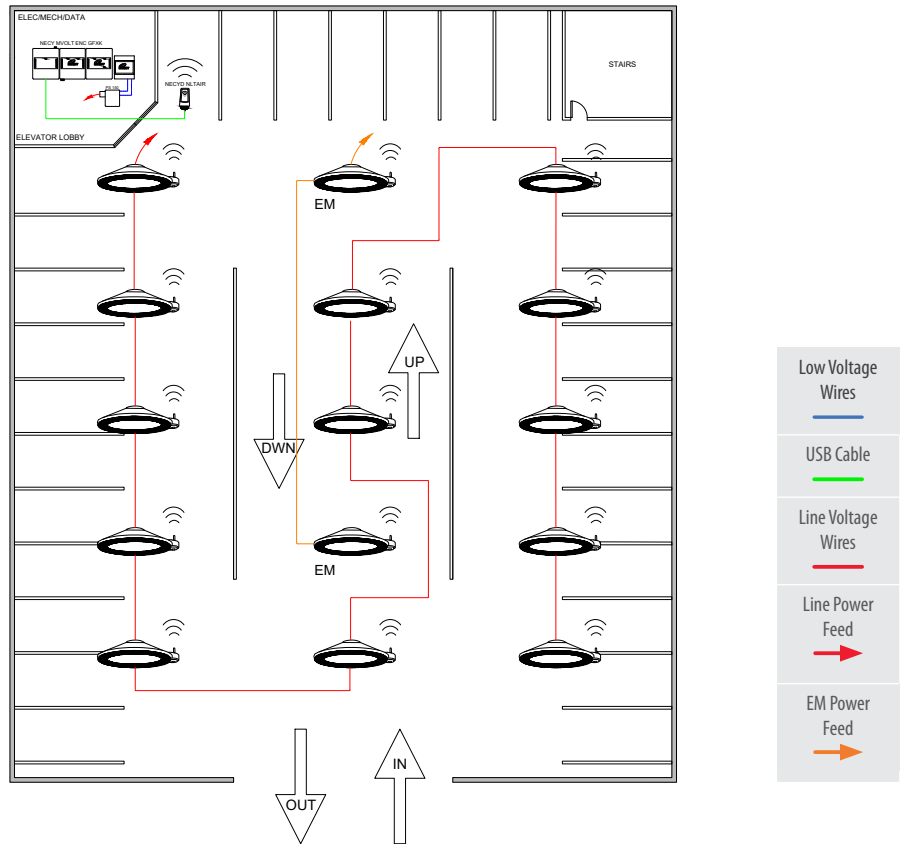

Bill of Materials

Symbol	Qty	Product #	Description
	13	See Note	Canopy Luminaire with Wireless Networked Embedded Controls from nLight with Sensor Option
	2	See Note	Canopy Luminaire with Wireless Networked Embedded Controls from nLight with Sensor and Emergency Option
	1	nECY	nLight ECLYPSE Network System Controller
	1	nECYD NLTAIR G2	nLight AIR Adapter

OPERATIONAL DETAILS:

Light Fixtures:

- All fixtures are dimmable
- All fixtures can be controlled together or independently
- Maximum level can be task tuned to any percentage via programming

Occupancy Control:

- Fixtures automatically go to full bright when occupied
- Fixtures automatically turn off or optionally can be configured to drop to low dim setting when space becomes vacant

Daylight Control:

- Daylight responsive controls lights to full off when adequate daylight present

ADDITIONAL OPTIONS:

- Devices can be connected to nLight backbone to embedded network control or time schedules, including astronomical time schedules for shutoff. GFKX option can be added to nLight ECLYPSE to provide manual override (9.4.4.1[a]).
- Luminaires with wireless networked embedded controls from nLight and occupancy/daylighting sensor options available, please see the fixture specification sheet
- For emergency lighting control use a power pack with ER/EM option or luminaire with networked embedded controls from nLight with emergency option

Note: Contact your local lighting agent for more information on luminaires with networked embedded controls from nLight.

Wireless Exterior Lighting

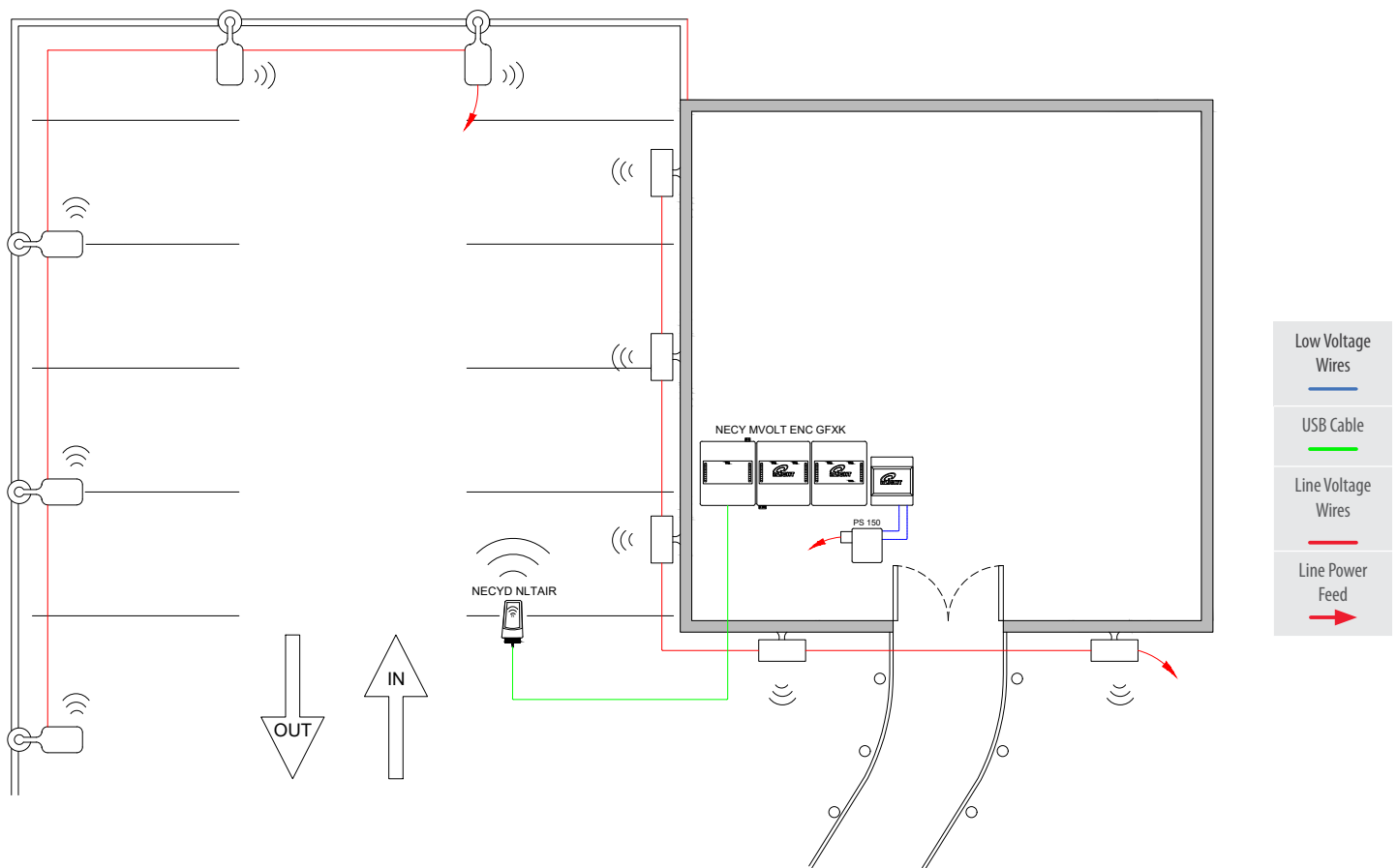

Bill of Materials

Symbol	Qty	Product #	Description
	5	See Note	Area Luminaire with Wireless Networked Embedded Controls from nLight
	5	See Note	Wall Mount with Wireless Networked Embedded Controls from nLight
	1	nECY	nLight ECLYPSE Network System Controller
	1	nECYD NLTAIR G2	nLight AIR Adapter

/ OPERATIONAL DETAILS:

Light Fixtures:

- All fixtures are dimmable
- All fixtures can be controlled together or independently
- Maximum level can be task tuned to any percentage via programming

Occupancy Control:

- Fixtures automatically go to full bright when occupied
- Fixtures automatically turn off or optionally can be configured to drop to low dim setting when space becomes vacant

Daylight Control:

- Daylight responsive controls lights to full off when adequate daylight present

/ ADDITIONAL OPTIONS:

- Devices can be connected to nLight backbone to embedded network control or time schedules, including astronomical time schedules for lighting shutoff (9.4.1.4[b]) and lighting setback (9.4.1.4[c]). GFXK option can be added to nLight ECLYPSE to provide manual override (9.4.4.1[a]).
- Luminaires with wireless networked embedded controls from nLight and occupancy/daylighting sensor options available, please see the fixture specification sheet
- For emergency lighting control use a power pack with ER/EM option or luminaire with networked embedded controls from nLight with emergency option

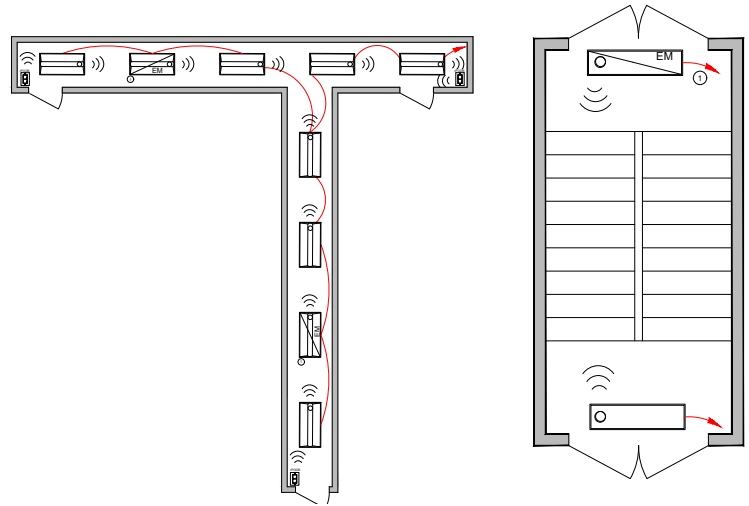
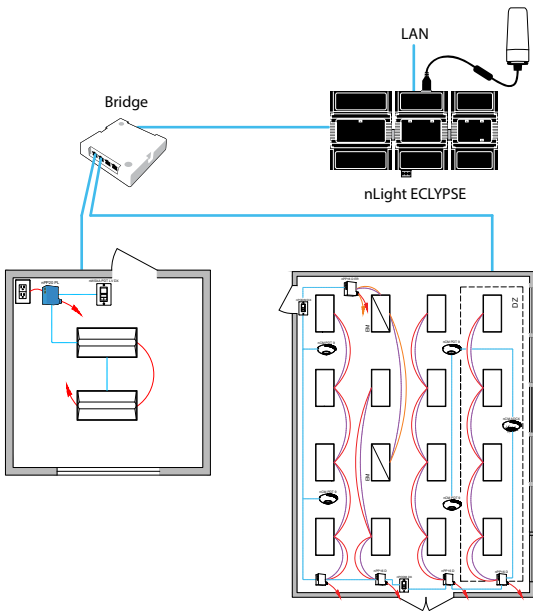

Note: Contact your local lighting agent for more information on luminaires with networked embedded controls from nLight.











Programmable Time Clock Control:

Although not pictured within each of the individual room design guides, each nLight controlled space can be connected via an nLight backbone to create a networked nLight lighting control system capable of meeting the requirements for scheduled shutoff. A networked system also enables astronomical time clock control.



Bill of Materials

Symbol	Qty	Product #	Description
	1	nBRG 8 KIT	8-Port Backbone Bridge
	1	nECY MVOLT ENC	nLight ECLYPSE Network System Controller and Optional BMS Interface
	1	nECYD NLTAIR G2	nLight AIR Adapter

Control Requirement	Code Provision	nLight Solution Details	
Manual Control (Local Switch)	C405.2.3	<p>nLight WallPod devices provide a user with local control of lighting within an nLight controlled space. WallPods are available in multiple styles – each with varying features and user experiences.</p>	
		<p>Push-Button WallPod</p> <p>nPODMA Series rPODBA Series rPODLA Series</p> 	<p>Graphic WallPod*</p> <p>nLight UNITOUCH Touchscreen Wall Switch</p> 
		Traditional tactile buttons and LED user feedback.	Full-color touch screen provides a sophisticated look and feel.
Shut-Off Control Time-Switch Controls and Exterior Lighting Control (via System Controller)	C405.2.2.1 C405.2.7	<p>Individual nLight control groups (i.e.: rooms) can be easily networked together across an entire building simply by connecting them into a “backbone” made up of one or more nLight bridge devices and/or nLight AIR adapters and an nLight ECLYPSE system controller. The system controller provides programmable time clock functionality for an nLight network as well as interfaces to the SensorView suite of web-based software applications (via an Ethernet LAN / WAN connection).</p>	
		<p>Network System Controller</p>  <p>Network System Controller</p>	
		<p>Additional benefits of installing an nLight backbone include remote status monitoring, system-wide configuration changes, and BMS interface capability.</p>	
Full Auto-Off via Occupancy Sensor	C405.2.1.1.1	<p>nLight occupancy sensors utilize 100% digital passive infrared (PIR) detection, come in several mounting styles, and offer multiple coverage pattern options. Additionally, nLight sensors are available with patented Microphonics™ dual technology detection for rooms with obstructions. Configuring for full off vs. partial off control is done with system programming.</p>	
Manual On, Auto-On <=50%, Full Automatic On	C405.2.1.1.2	<p>360° Occupancy Sensor</p> <p>nCM Series rCMS Series rCMSB Series</p> 	<p>120° WideView Corner Sensor*</p> <p>nWV Series</p> 
		Surface mounts to ceiling tiles or sheetrock/plaster.	Directly mounts in corner or to ceiling via repositionable ceiling bracket.
		<p>nLight provides multiple options for controlling continuous dimming luminaires. This allows spaces with several lighting types and technologies to be controlled together and with a common user experience.</p>	
Light-Reduction Controls	C405.2.2.2	<p>Acuity Brands Luminaires with Networked Embedded Controls from nLight</p> 	<p>Dimming Relay Packs</p> <p>nPP16 Series rPP20 Series</p> 
		Acuity Brands offers a wide variety of LED fixtures with factory installed embedded controls from nLight that provide smooth continuous dimming.	nLight dimming relay enable control of any 0-10VDC dimmable LED luminaire.
		<p>nLight offers standalone daylight harvesting sensors as well as occupancy sensors with integrated daylight harvesting. Sensors are available in various housings and provide continuous dimming control of any/all luminaires with networked embedded controls from nLight or dimming relay packs, each capable of being its own daylight zone.</p>	
Daylight-Responsive Controls	C405.2.4	<p>Ceiling Mount Dimming Photocell</p> <p>nCM Series rCMS Series rCMSB Series</p> 	<p>Recessed Mount Dimming Photocell*</p> <p>nRM Series</p> 
		<p>nLight offers standalone daylight harvesting sensors as well as occupancy sensors with integrated daylight harvesting. Sensors are available in various housings and provide continuous dimming control of any/all luminaires with networked embedded controls from nLight or dimming relay packs, each capable of being its own daylight zone.</p>	
		<p>nLight offers standalone daylight harvesting sensors as well as occupancy sensors with integrated daylight harvesting. Sensors are available in various housings and provide continuous dimming control of any/all luminaires with networked embedded controls from nLight or dimming relay packs, each capable of being its own daylight zone.</p>	

*Available with nLight Wired products only.

Note: This summary is for general information purposes only and is provided without any warranty as to accuracy, completeness, or otherwise. The user should read the applicable code sections for more complete and detailed descriptions of code requirements and exceptions and should consult with a professional engineering or other competent advisor before making any decision or taking any action based on this summary.

Control Requirement	Code Provision	nLight Solution Details	
Additional Controls	Automatic Receptacle (i.e. Plug Load) Control	C405.6.1	
			<p>The nLight Plug Load Relay Pack is capable of switching an entire 20A receptacle load. Simply add an occupancy sensor to an nLight Control Zone (room) and the sensor will automatically switch off when the room is vacant.</p>
			<p style="text-align: center;">Plug Load / Receptacle Relay Pack</p> <div style="display: flex; justify-content: space-around; align-items: center;"> <div style="text-align: center;">  <p>nPP20 PL Series</p> </div> <div style="text-align: center;">  <p>rPP20 Series</p> </div> </div>

Other Lighting Control Requirements

C405.2.4.3

Hotel/Motel Sleeping Units and Guest Suites:

Master control device turns off all installed luminaires and switched receptacles within 20 minutes of occupants leaving.

Exceptions:

Lighting and switched receptacles controlled by a captive key system.

C408.3

Lighting System Functional Testing:

Before final inspection, a registered design professional provides evidence that lighting controls have been tested, calibrated, adjusted, programmed, and are in working condition:

C408.3.1.1: Test occupancy sensors

C408.3.1.2: Test auto time switch

C408.3.1.3: Test daylight responsive

C405.2.5

Exterior Lighting Controls:

- Automatically turn lights off with daylight
- Facade, landscape lights automatically turn off as a function of dusk/dawn and open/close time
- Reduce all other lighting by ≥30% from no later than midnight to 6AM, one hour after closing to one hour before opening, or when no activity is detected for > 15 minutes

Exceptions:

- Auto off emergency lighting
- Lighting for health and safety
- Covered vehicle entrances
- Building/parking structure exits for safety, security, or eye adaptation

C406

Additional Efficiency Package:

Note: Lighting options listed below, other options include: HVAC, renewable energy, outdoor air, service water heating.

C406.3: Reduced lighting power density:

Use 90% of total interior lighting power as identified in Table C405.4.2(1) or by using Space-by-Space method from C405.4.2.

C406.4: Enhanced digital lighting controls:

Continuous dimming, individually addressable luminaires, daylight zones, digitally reconfigurable, load shedding, individual user control, digitally reconfigurable occupancy sensor.

*This summary is for general information purposes only and is provided without any warranty as to accuracy, completeness, or otherwise. The user should read the applicable code sections for more complete and detailed descriptions of code requirements and exceptions and should consult with a professional engineer or other competent advisor before making any decision or taking any action based on this summary.

Mobile Apps

Quick and Easy Lighting Configuration and Control In the Palm of Your Hand

nLight Wired



nLight BLE Radio Module

nLight wired uses the nIO BT (Bluetooth® Low Energy radio module) to communicate with the nConfig app to modify the settings and operation of the devices in an nLight zone.

The Bluetooth® word mark and logos are registered trademarks owned by Bluetooth SIG, Inc. and any use of such marks by Acuity Brands Lighting is under license.

nConfig™

The nConfig mobile app is for nLight wired controls startups. It's a quick and easy alternative to SensorView software for smaller projects and simple programming.

nLight AIR



CLAIRITY™ Pro

The CLAIRITY Pro mobile app allows you to start up, configure and troubleshoot nLight AIR wireless controls from a compatible smartphone or tablet.

The **myPERSONIFY mobile application** is an easy-to-use, intuitive tool that allows for control of scenes, lights, and shades directly from a mobile device when connected to an nLight UNITOUCH. For today's occupants, the myPersonify app offers enhanced flexibility and the convenience of wireless control for nLight devices in the space they occupy.



Luminaires with Networked Embedded Controls from nLight

Acuity Brands offers the industry's broadest portfolio of luminaires with networked embedded controls from nLight. Please scan the QR code to see the current luminaires with networked embedded controls from nLight.



Luminaires with Wireless Networked Embedded Controls from nLight



Luminaires with Wired Networked Embedded Controls from nLight

Specification Tools

We have developed a set of productivity tools to help you do your job faster and easier, allowing you to specify and design with confidence.

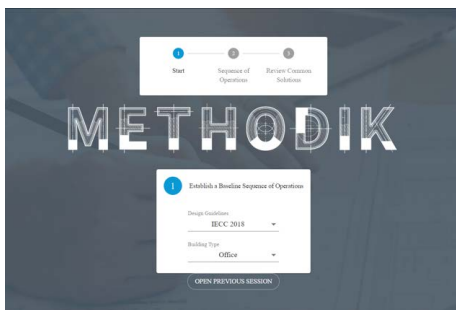

Develop Your Sequence of Operations Faster

Methodik is an online tool that generates a sequence of operations quickly, designed to save time and increase your productivity. The sequence of operations can export your project into DXF, PDF, and CSV file formats to include in your electrical set. Additionally, it gives recommendations on products that can be used in each space--fixtures and controls side by side.

[Get The Tool!](#)



Spec Builder - Build Your Spec Faster and Easier

We have developed an online tool designed to make the creation and manipulation of project specifications faster and easier.

Spec builder includes 26 network lighting controls specifications language, as well as Div 23 and 25.

[Build Your Spec Now!](#)



A Quicker Way to do a Design Take-Off

The Visual Controls software supports efficient design and specification with Acuity Controls. You can quickly perform a design take-off to bid a project and generate a comprehensive professional submittal.

To get access to the Visual Controls software, please contact your local lighting agent to get access today.

[Get Access Now](#)



Acuity Controls Typical Layout Drawings

<https://www.acuitybrands.com/resources/tools-and-documents/typicals>

Florida Building Code - Energy Conservation - 2017 - 6th Edition

<http://www.floridabuildingcode.org/>

Use the Following Sections of the Florida Code as Reference:

- Section C405.2.1.1.1 – Full Auto-Off via Occupancy Sensor
- Section C405.2.1.1.2 – Manual-On or Partial-On
- Section C405.2.1.1.2 – Full Automatic On
- Section C405.2.1.3 – Local Switch
- Section C405.2.2.1 – Programmable Timeclock
- Section C405.2.2.2 – Manual Lighting Reduction
- Section C405.2.3.1/2 – Daylight-Responsive Controls
- Section C405.2.5 – Exterior Lighting Controls
- Section C406.4 – Enhanced Digital Lighting Controls

Explore Acuity Academy

Acuity Academy provides educational resources for individuals wanting to expand their lighting, controls and building management technical knowledge. On Acuity Academy, you can register for instructor-led classes, take e-learning courses or watch videos and recorded content. <https://www.acuitybrands.com/resources/training-and-education>

nLight Lighting Controls Platform Page

www.acuitybrands.com/nlight



A+ Certified solutions from Acuity Brands help you quickly and confidently select and implement lighting systems that are both compatible and consistent.

For lighting applications, A+ means verified consistent performance, visual appearance and system interoperability of all luminaires and controls within the certified solutions. For lighting professionals it means confidence that all parts of the lighting system will work together and meet common Acuity Brands specifications.

Go to www.acuitybrands.com/solutions/a-certified or contact your local Acuity Brands representative for more information.

The Bluetooth® word mark and logos are registered trademarks owned by Bluetooth SIG, Inc. and any use of such marks by Acuity Brands Lighting is under license.